

# B7536108

Cover 36

Suitable for CONTROL-KNOBS 36. Simply push on.

## Supply

1 cover

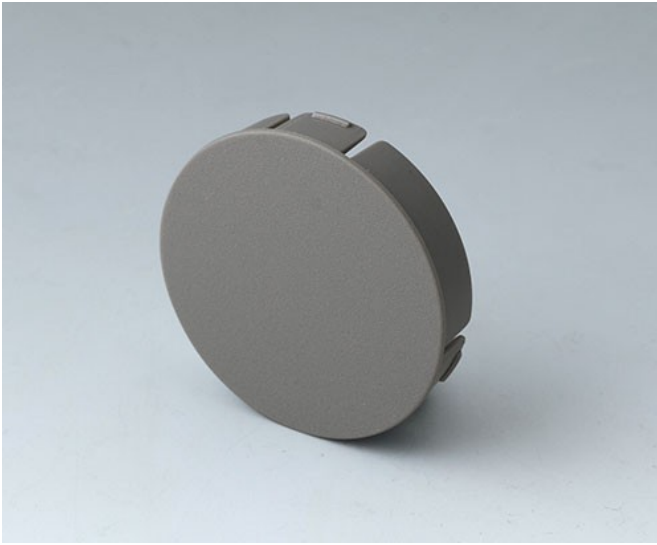

## TECHNICAL DATA

Material	PA 6
Colour	volcano

Please take the dimensions from current parts. These are subject to material- and manufacturing-specific tolerances.

## PURCHASING DATA

Weight/1 part	2 g
Customs tariff number (OKW product)	39269097
Country of manufacture	Germany

## CUSTOMISING OPTIONS

What else do you need to create your own personal product? We can supply our enclosures and tuning knobs fully modified to suit your electronic components and design requirements. Please advise for anything else we can do for you.

**Customising options for B7536108**

# B7536108

Cover 36



Machining



Printing



Laser marking

# B7536108

## Cover 36

### SYSTEM COMPONENTS TO COMPLETE



**B7136061**  
 CONTROL-KNOBS 36, optional  
 illumination  
 PC  
 nero  
 36x14.7mm 6mm



**B7136062**  
 CONTROL-KNOBS 36  
 PC  
 nero  
 36x14.7mm 6mm



**B7136063**  
 CONTROL-KNOBS 36, optional  
 illumination  
 PC  
 volcano  
 36x14.7mm 6mm



**B7136064**  
 CONTROL-KNOBS 36  
 PC  
 volcano  
 36x14.7mm 6mm



**B7136631**  
 CONTROL-KNOBS 36, optional  
 illumination  
 PC  
 nero  
 36x14.7mm 1/4"



**B7136632**  
 CONTROL-KNOBS 36  
 PC  
 nero  
 36x14.7mm 1/4"



**B7136633**  
 CONTROL-KNOBS 36, optional  
 illumination  
 PC  
 volcano  
 36x14.7mm 1/4"



**B7136634**  
 CONTROL-KNOBS 36  
 PC  
 volcano  
 36x14.7mm 1/4"

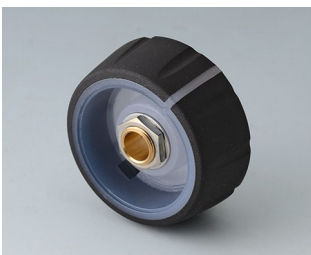

**B7236061**  
 CONTROL-KNOBS 36, optional  
 illumination  
 PC  
 nero  
 36x14.7mm 6mm



**B7236062**  
 CONTROL-KNOBS 36  
 PC  
 nero  
 36x14.7mm 6mm

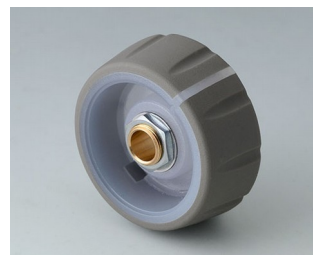

**B7236063**  
 CONTROL-KNOBS 36, optional  
 illumination  
 PC  
 volcano  
 36x14.7mm 6mm



**B7236064**  
 CONTROL-KNOBS 36  
 PC  
 volcano  
 36x14.7mm 6mm

# B7536108

## Cover 36



**B7236631**  
CONTROL-KNOBS 36, optional  
illumination  
PC  
nero  
36x14.7mm 1/4"



**B7236632**  
CONTROL-KNOBS 36  
PC  
nero  
36x14.7mm 1/4"

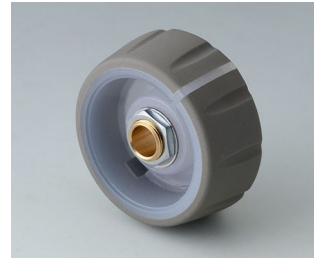

**B7236633**  
CONTROL-KNOBS 36, optional  
illumination  
PC  
volcano  
36x14.7mm 1/4"

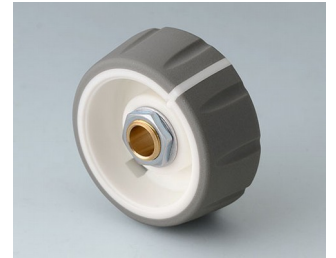

**B7236634**  
CONTROL-KNOBS 36  
PC  
volcano  
36x14.7mm 1/4"

Subject to technical modification without notice. © by OKW Gehäusesysteme, Buchen/Germany.

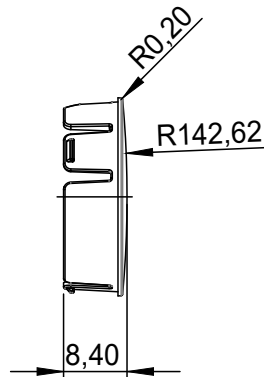
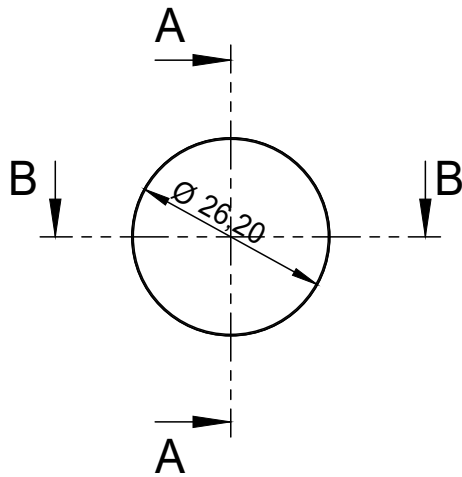

### Schnitt A-A

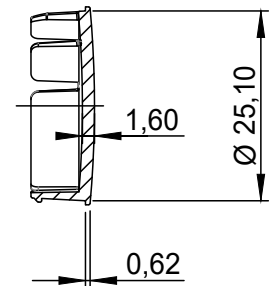

### Schnitt B-B

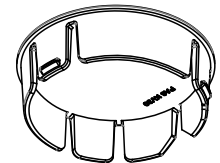
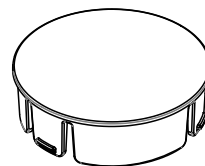
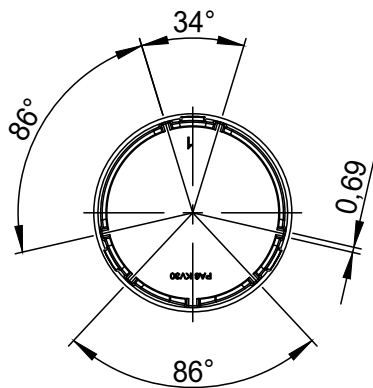
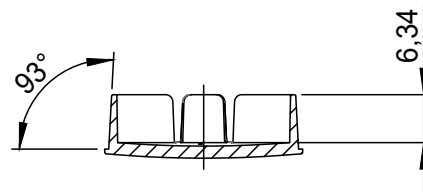
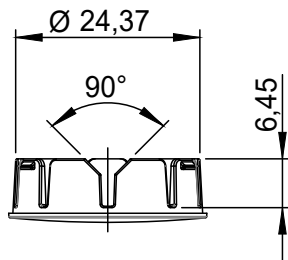

Bitte die Maße an aktuellen Teilen abnehmen.  
Diese unterliegen material und produktionsspezifischen  
Fertigungstoleranzen

Please take the dimensions from current parts.  
These are subject to material- and manufacturing-  
specific tolerances

Informationskopie  
wird nicht aktualisiert  
Copy for Information  
will not be updated

Erst. am: 27.04.2020  
Erst. von: O. Herrlich  
Freig. am:  
Freig. von:  
Revision: 01

Toleranzen:  
DIN 16742 TG 6

Status:  
ENTWICKLUNG

Volumen:

Zeichnungsart:  
KUNDE

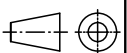

DIN 6 Teil 2

Technische Änderungen vorbehalten. Irrtümer oder Druckfehler  
begründen keinen Anspruch auf Schadenersatz. Wichtige Ein-  
baumaße bitte direkt mit dem aktuellen Produkt abstimmen.

Subject to technical modification without prior notice. Typogra-  
phical and other errors do not justify any claim for damages. All  
dimensions should be verified using an actual moulded part.

Sous réserve de modifications techniques. Toute erreur ou faute  
d'impression ne justifie aucune demande d'indemnisation. Nous  
prions les clients de vérifier les dimensions des composants avec  
les boîtiers avant le montage.

**OKW**  
**GEHÄUSE**  
**SYSTEME**

This document contains proprietary information of OKW Gehäusesysteme GmbH  
and is tendered subject to the conditions that the information be retained in confidence  
not be reproduced or copied and not be used or incorporated in any product.

**CONTROL-KNOBS 36**  
**Deckel / Cover**

**B753610\***

M 1:1

Für dieses Dokument behalten wir uns alle Urheberrechte vor. Es darf auch auszug-  
weise weder vervielfältigt noch Dritten in irgendeiner Form zugänglich gemacht werden.

Dateiname:  
00027315